

ELECTRICAL

GENERAL

The Citation Sovereign electrical system is a split bus type. The split bus design allows the left- and right-hand systems to operate independent of each other. The right-hand emergency bus receives power via the right-hand generator, battery or an external power source. The left-hand emergency bus receives power from the left-hand battery, generator or the Auxiliary Power Unit (APU). The DC electrical system provides 300 amperes (275 amperes above 35,000 feet) at 28.5 volts from each engine driven generator. The single APU driven generator provides 275 amperes at 28.5 volts up to 30,000 feet. The two engine driven generators can be operated simultaneously with the APU generator in a standby mode. Generator Control Units (GCUs) provide voltage regulation, over voltage protection, over excitation and ground fault protection. One GCU is installed for each engine driven generator and for the APU generator.

The main electrical control panel located on the lower right-hand side of the pilot's instrument panel provides control for the electrical system. Push-button switch-annunciators are used as a means of control for avionics power, battery power, opening or closing of the bus-tie (only in flight), external power, interior power, and power to the EICAS system. Toggle switches control the left and right hand generators, standby power (provided by the standby battery) and emergency lighting.

Control for the APU generator power is located on the APU system panel on the co-pilot's side console.

Two 44 amp-hour batteries, left and right, provide airplane battery power. Power from the batteries is made available to the airplane by use of the L or R BATT switch annunciators located on the main electrical panel.

A Ground Power Unit (GPU) receptacle allows for the use of a GPU. Power supplied by the GPU is made available for use by the EXT PWR switch-annunciator on the main electrical panel.

DIRECT CURRENT (DC) POWER

The engine driven generators, the batteries and an on-board Auxiliary Power Unit (APU) provide the DC power required to operate all airplane DC powered equipment. The L GEN, R GEN, and the APU System GENERATOR switches select generator power. With the L GEN, R GEN or GENERATOR switches in the ON position, the GCUs will place the respective generator on-line when the engines or APU are running. The left and right engine generators operate independent of one another. No load paralleling is available. The APU driven generator will not come on-line or will drop off-line if the left engine generator is on-line. The RESET position on the L GEN and R GEN toggle switches is momentary and will reset the respective GCU after a system trip has occurred.

ELECTRICAL SYSTEM BLOCK DIAGRAM

A28845

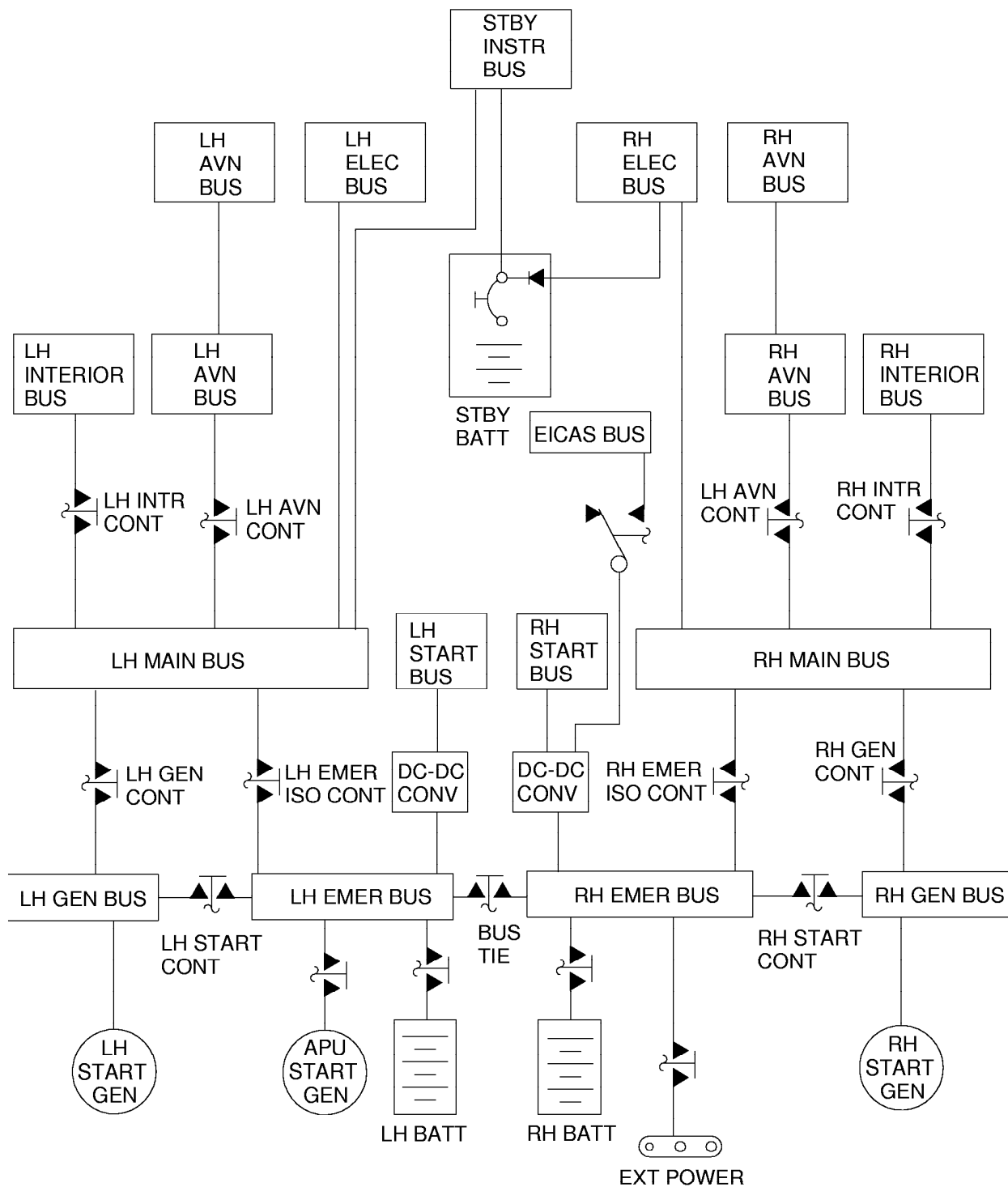

6985T1003

Figure 2-19

DIRECT CURRENT (DC) POWER INDICATORS

The voltage and amperage of the engine-driven DC generators can be read from the electrical portion of the EICAS system. The voltage and amperage of both generators and the temperature of both batteries may then be read simultaneously. Eight different digital EICAS messages may be annunciated to apprise the crew of abnormal electrical system operation.

Any abnormal condition will be presented on the EICAS display as a red, amber, or cyan CAS message. A red CAS message along with the MASTER WARNING light will flash until it is acknowledged. An amber message will cause the master caution light to illuminate steadily, and the message will flash until it is acknowledged. Cyan advisory messages will appear and flash for five seconds then annunciate steadily. The messages that can be presented are: BATTERY O'CURRENT L-R (amber), BATTERY OFF L-R (amber or cyan), BATTERY O'TEMP L-R (red), BUS TIE CLOSED (amber or cyan), DC EMER BUS L-R (amber or cyan), DC GEN O'CURRENT L-R-APU (red or amber), DC GEN OFF L-R-APU (red or amber), and REMOTE CB TRIPPED (cyan).

Specific causes for the appearance of the messages are covered under Engine Indicating and Crew Alerting System (EICAS) in this section. The ammeters function as load meters indicating the load being carried by each generator or by the onboard auxiliary power unit. When the auxiliary power unit is in operation output current can be monitored at all times on the APU ammeter (DC AMPS APU) which is mounted on the copilot's meter panel.

AUXILIARY POWER UNIT AMMETER



Figure 2-20

GENERATORS

Each engine is equipped with a starter/generator rated at 300 amperes (275 amperes above 35,000 feet for engine generators). The APU is equipped with a generator rated at 275 amperes up to 30,000 feet. The generators are self cooled on the ground and are cooled by ram air when in flight. The generator serves two functions: (1) to generate direct current (DC) power for the airplane systems and, (2) to charge the airplane batteries and the standby battery.

The generators normally provide 28.5 volts direct current (DC) to their respective bus. Generator number one to bus number one (left main bus), generator number two to bus number two (right main bus), and the APU generator to the left emergency bus. An overvoltage of approximately 31.5 volts will cause a generator to go off-line.

The engines are normally started with the L and R GEN switches in the ON position. If the engines are started with the L and R GEN switches in the ON position, the generator control units (GCU's) will bring their respective generators online automatically.

The RESET position of the L and R GEN switches is a momentary position, and is used to reset the generators before placing them into operation when there has been a system trip.

Each generator is wired directly to a separate power junction box, and each has electrical terminal filtering to suppress radio noise output. A single generator is capable of supporting the entire electrical system requirements. Generator limitations are the same whether one or both generators are in operation.

An overvoltage protection system is provided during use of an external power unit. The control unit monitors the external power unit voltage and will de-energize the external power relay, removing power, if the voltage exceeds 31.0 (± 0.5) volts. External power cannot be reapplied to the airplane until the voltage is reduced.

AFT POWER AND AC JUNCTION BOXES, AND LOGIC MODULES

The main left and right power junction boxes and the alternating current (AC) junction boxes are located in the aft baggage compartment. These junction boxes incorporate a number of major relays, logic modules, and circuit breakers that supply remote signals which provide warning and caution messages to the EICAS system. Some of the logic modules record circuit breaker trips and system malfunctions for facilitation of later ground maintenance. Other logic modules are located in the pilot's side console. Refer to the airplane Maintenance Manual and to the Wiring Diagram Manual for a listing of the circuit breakers by number and function for each of the junction boxes and logic modules.

GENERATOR CONTROLS AND SWITCHES

A three-position generator switch, located on the tilt panel (DC Power Panel), immediately to the left of the pedestal, is provided for each generator. The switch is labeled L or R GEN, ON, OFF and RESET. Selecting the ON position with the engine running will supply a signal to the generator control unit, which monitors the battery bus voltage and generator condition. It will connect the generator to the bus when the FADEC signal "READY TO LOAD" is received and generator voltage is sufficient. Placing the switch to the OFF position will disable the signal to the generator control unit, the generator will be dropped off-line, and the respective (amber) DC GEN OFF L-R annunciation will appear. The RESET position is a momentary position that will momentarily connect the armature directly to the field creating a rapid buildup to 28.5 volts. The switch is spring-loaded from the RESET back to the OFF position; therefore, it must be manually positioned to ON when the RESET feature is utilized, and the generator will then come back on line. The RESET position will reset a generator that has been tripped as a result of an overvoltage, feeder fault, or if the fuel and hydraulic firewall shutoff valves have been activated. Generator operation will again be disabled during reset attempts if the fault still exists or until the firewall shutoff valves have been de-activated. The MASTER WARNING indicator will flash at any time both generators have faulted or have been tripped off-line for any reason, and a red DC GEN OFF L-R CAS message will appear in the flashing mode. An attention tone will also be heard, and if the voice warning system is installed a voice synthesis will be heard until the annunciation acknowledged.

DIRECT CURRENT (DC) POWER GENERATION DISTRIBUTION

DC power originating from the batteries, airplane generators, on board auxiliary power unit or ground external power sources, is initially controlled with different main DC power busses being activated by power contactors located in the aft power junction box (J-Box). Three separate junction boxes are located at the forward end of the baggage compartment. The main electrical power J-Box contains components of the emergency electrical system. Three electrical, three avionics, and one interior cable per main J-Box route DC power to the right and left circuit breaker panels in the cockpit. Current limiters and circuit breakers protect the entire system. An isolation relay separates the DC emergency bus from the main bus so that, if required, the emergency bus may be separated from the other busses and their loads.

The left and right feed busses are connected through a bus-tie relay. The bus-tie relay is closed on the ground during initial power up and then opens automatically when the second generator comes on-line after engine start on the ground. This allows the left and right electrical systems to operate independently. The bus-tie relay can be pilot controlled in the air (automatic on the ground) using a bus-tie/OPEN, CLOSED switch annunciator in the electrical switch panel. In the event that a generator overcurrent causes a generator to be automatically shut off, the crosstie relay will be latched open and cannot be selected closed.

SAFETY AND PROTECTIVE FEATURES OF THE SYSTEM ARE:

No more than one generator will be connected to a single bus at any time.

Ground external power overvoltage protection is provided.

Two separate and distinct distribution systems, and related subsystems, supply power.

No malfunctioning power source can prevent the remaining power sources from furnishing power to essential loads.

Individual, or collective disconnection of the electrical power sources, including batteries, is available in flight to the flight crew.

When fuel and hydraulic firewall shutoffs are activated, the respective generators are de-activated, and cannot be re-activated until the fuel and firewall shutoffs are reopened.

Generator overvoltage protection at 31.5 (± 0.5) volts is provided.

All circuit breakers are "push-to-reset" and cannot be reset if a fault is present in the circuit.

Each battery is provided with a separate switch to provide for individual battery disconnection.

ELECTRICAL POWER/ENGINE CONTROL PANEL

A28847

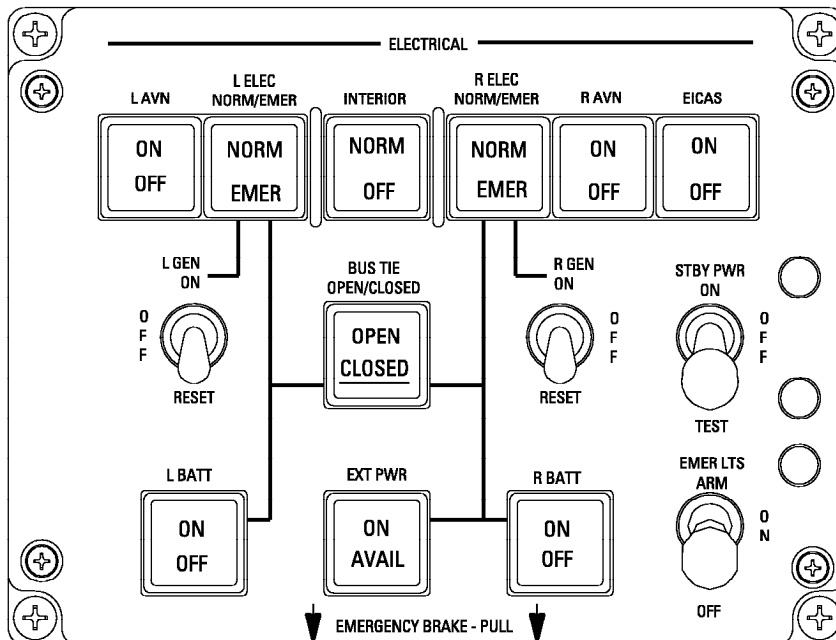

6918T1071

Figure 2-21

BATTERY

Two 44 ampere-hour nickel-cadmium batteries are connected directly to their respective left and right battery busses, which are connected, through isolation relays, to the emergency battery bus.

Battery power is selected by the L BATT and R BATT switch-annunciators. Battery 1 is located in the left aft fuselage fairing and Battery 2 is located in the right aft fuselage fairing. They are vented overboard through tubes located on the belly beneath the batteries. Selecting L BATT or R BATT supplies battery power to the respective left- and right-hand emergency busses and also allows battery charging. The batteries are a secondary source of direct current (DC) power that is used to provide power during the engine starting sequence and to provide power to the emergency battery bus in the event of a dual generator failure. With no generator on-line and the L ELEC and R ELEC switch-annunciators set to NORM, the batteries will provide power to all aircraft systems (except interior systems) for approximately 23 minutes for the left-hand battery, and 21 minutes for the right-hand battery. No battery power is provided to the INTERIOR switch-annunciator with no generator on-line and the L or R ELEC switch annunciators in the NORM position. Selecting both bus switches to EMER within 5 minutes after loss of generator power will allow the battery busses to supply power for approximately 60 minutes to the emergency bus equipment.

The main batteries are supplemented by a 10.5 ampere-hour, 24 VDC lead-acid power pack, located in the airplane nose compartment, which provides emergency electrical power to the standby instruments.

External power is applied to the right-hand emergency bus when the ground power unit (GPU) is connected to the airplane and the GPU is started. The EXT PWR switch-annunciator will illuminate the AVAIL annunciator when external power is being provided by a GPU. When placing the EXT PWR switch-annunciator to ON, external power is applied to the right-hand emergency bus. External power then becomes available to the complete airplane electrical system. Ground external power will automatically be disconnected by the external power relay when a generator switch is placed to the ON position after an engine has been started.

Both airplane batteries will charge from the ground power unit. With either battery switch in BATT and the ground power unit connected and in operation, external power will be applied to the airplane busses and the respective battery will be charged. The ground power unit should have the voltage adjusted to maintain 28.5 (± 0.5) volts.

Temperature sensors located within the battery assembly continuously monitor cell temperatures and provide a variable signal to the EICAS display. Normal battery operating temperature is between -20°C and 63°C . Battery temperature will be displayed in the electrical portion of the EICAS system. If the battery temperature falls below -20°C , battery temperature will be displayed in black on amber inverse video on the EICAS. A battery overheat condition will cause the MASTER WARNING RESET light to flash and the EICAS to display a red battery overheat warning message of BATTERY O'TEMP L or R and an aural "BATTERY OVERTEMPERATURE" warning will be heard.

NOTE

When battery temperature has been exceeded, the battery must be serviced per the maintenance manual.

GENERATOR CONTROL UNIT (GCU)

Three GCUs, one for each starter/generator, are installed in the aft tailcone. The GCU is used to control the operation of the starter/generator and provides the following control features:

Voltage regulation at 28.5 VDC.

Overvoltage protection at 35.0 VDC.

Reverse current control of the line contactor.

Generator feeder ground fault protection.

Start contactor control and field weakening during start.

Overspeed sensing and protection resulting from sheared starter shaft.

Generator self-excitation and subsequent regulation without an external source of power (such as a battery).

Generator deactivation when the firewall shut-off is activated.

Protective Functions

Reverse Current Protection
Overvoltage Protection
Overexcitation Protection
Reverse Polarity Protection
Overspeed Protection (Start Cycle)
Anti Cycle Protection
Open Shunt Protection
Build Up Ground Fault Protection
Ground Fault Protection

Control Functions

Generator (Line) Contactor Control
Starter Field Current Control (Field Weakening, Torque Limiting)
Automatic Starter Cutout Control
Paralleling Control
Threshold Selection

EXTERNAL POWER

External direct current (DC) power can be connected to the airplane through a receptacle located on the right side of the fuselage. Ground power requirements dictate a 28-volt unit, with a nominal current capability of 1500 amperes. If an adjustable power unit is used, it should be adjusted to provide a setting of 1500 amperes. Ground power units with a soft start capability are preferable. The battery should be disconnected if the airplane is to be on a ground power unit for a prolonged period of time.

CIRCUIT BREAKERS





Push-to-reset, pull-off type circuit breakers, with the amperage rating marked on each breaker, are installed in panels located on both sides of the cockpit. The panels are readily accessible to the flight crew during flight. The panels shown are typical installations for the Sovereign.

Additional circuit breakers, to which flight crew access is not essential, are located in the tailcone junction boxes.

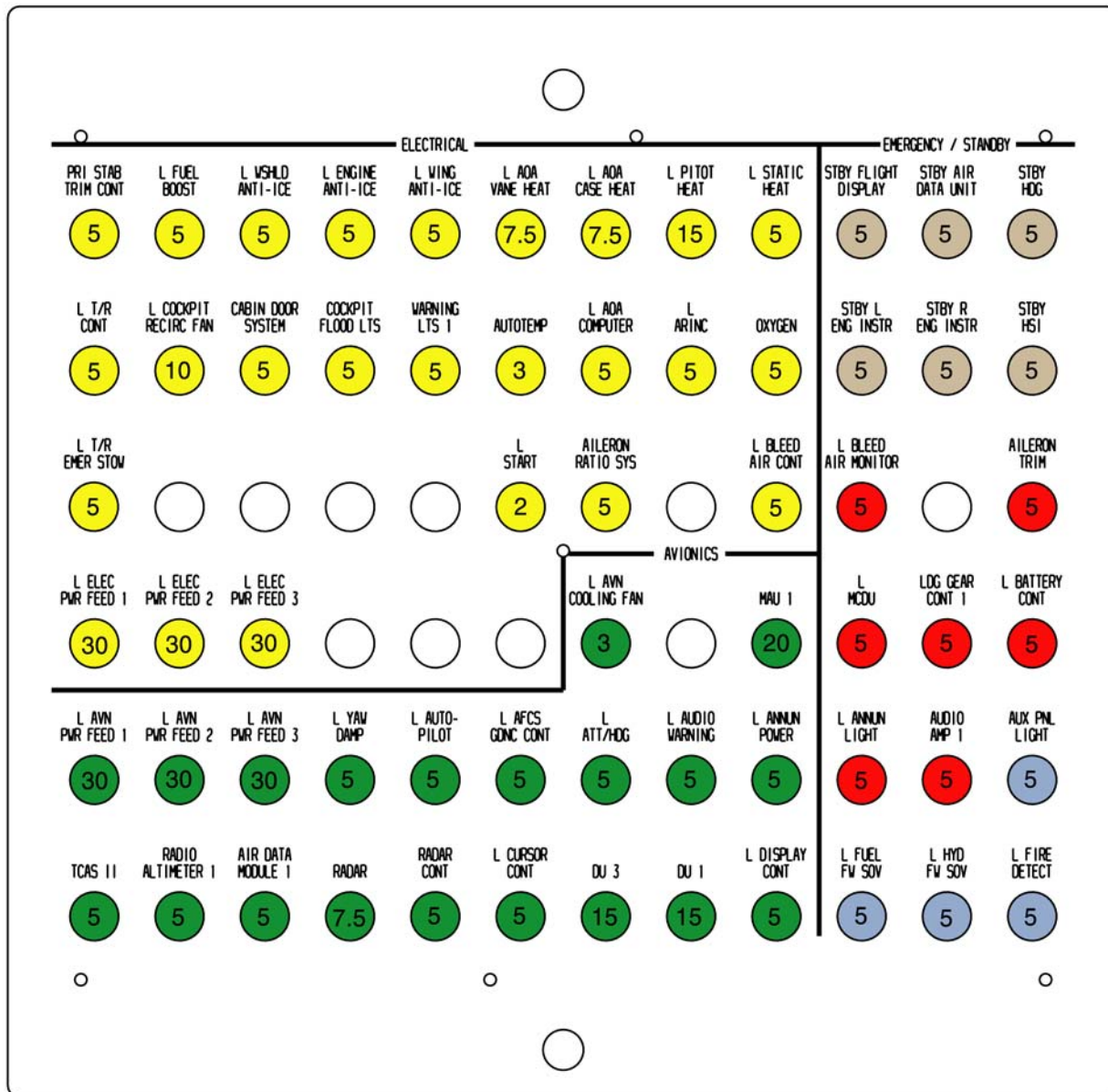
LEFT CIRCUIT BREAKER PANEL

A28825



-  LEFT EMERGENCY BUS
-  LEFT ELECTRICAL BUS
-  LEFT AVIONICS BUS
-  LEFT START BUS
-  STANDBY EQUIPMENT BUS

9914T690-5

Figure 2-22 (Sheet 1 of 2)

RIGHT CIRCUIT BREAKER PANEL

A28991

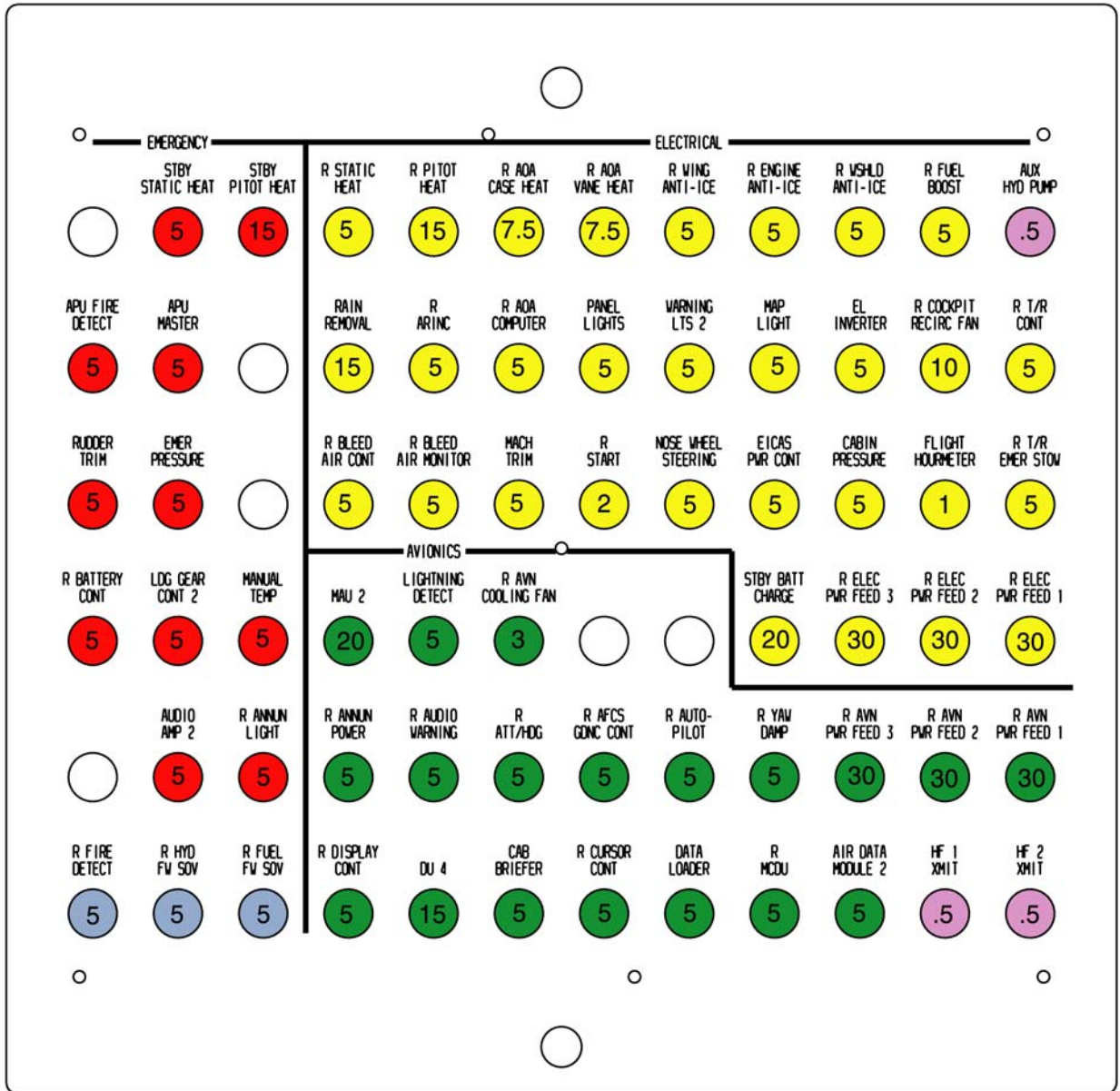

- RIGHT EMERGENCY BUS
- RIGHT ELECTRICAL BUS
- RIGHT AVIONICS BUS
- RIGHT START BUS
- NOT ON A BUS

9914T702-6

Figure 2-22 (Sheet 2)